

## Image Watermarking Based on 5/3 Wavelet Decomposition and Turbo-Code

<sup>1</sup>K.Venkata Ramana, <sup>2</sup>David Solomon Raju Y <sup>3</sup> B Pulla Rao

<sup>1</sup>Asst. Prof. Dept of EIE, VITS, Desmukh (v), Nalgonda,

<sup>2</sup>Assoc. Prof., Dept. of ECE, HITSCOE, Keesara

<sup>3</sup>Asst. Prof., Dept. of ECE, Dept. of ECE, HITSCOE, Keesara

<sup>2</sup>davidsolomonraju.y@gmail.com

---

**ABSTRACT:** This paper is an attempt to describe a new scheme of image watermarking based on 5/3 wavelet decomposition and turbo-code. This new watermarking algorithm based on embedding mark (signature) in the multi-resolution field. For the purpose of increasing the image watermarking robustness against attacks of an image transmission, we encode with a turbo code an image-embedded mark. This new scheme of image watermarking is able to embed 2000 bits in medical images. Results of experiments carried out on a database of 30 - 256×256 pixel - sized medical images show that watermarks are robust to Noises, Filter attacks and JPEG Compression. Results demonstrate that fidelity can be improved by incorporating turbo code- coding mark that is shaped into the embedding process. Other advantages of our embedding process are to preserve intellectual features and to secure the mark in the image. The image degradation is measured by Relative Peak Signal to Noise Ratio (RPSNR). Experimental results show that this unit of measurement is the best distortion metric which is correlated with Human Visual System (HVS); and therefore more suitable for digital watermarking.

**Keywords** - Watermarking, multi-resolution field, Error Correcting Codes, Turbo code, RPSNR, Robustness

---

### I. Introduction

Image watermarking allows owners or providers to hide an invisible and a robust signature inside images, often for security purposes and more precisely in particular owner or content authentication [1, 2]. Medicine has benefited of watermarking research to preserve medical deontology [3], [4] and facilitate distant diagnosis [5]. The watermarking is a solution to conserve the intellectual properties of a diagnostic image, as well as to maintain the perceptual fidelity. There are three parameters in digital watermarking: data payload, fidelity, and robustness. The reader is directed to [6] for a detailed discussion of these concepts.

In this paper, we develop a new scheme of a robust image-watermark algorithm able to embed large data payloads. This scheme attempts to attain an optimal trade-off between estimates of perceptual fidelity, data payload and robustness. This new scheme is able to embed 2000 bits in medical images with 256× 256 sized-pixels. We propose to embed the mark in the multi-resolution domain.

The embedded mark is coded with an Error Correcting Code (ECC): the turbo code. ECC has been successfully used in digital communication systems and data storage applications in order to achieve reliable transmission on a noisy channel. Therefore, in a more recent literature, one can find watermarking techniques that use more powerful error correcting codes, such as convolutional codes[7, 8], BCH codes[9, 10, 11] or concatenated codes based on a convolutional code followed by a Reed-Solomon code [12] or even Convolutional Turbo Codes [13, 14, 15]. As relevant to the above mentioned aim, we choose the turbo code as an ECC in our watermarking scheme. Since it achieves a high error-correction capability with a reasonable decoding complexity, the turbo code uses Soft Output. Viterbe Algorithm (SOVA) [8]. Turbo code allows us to embed large data payloads in medical images with keeping intellectual properties of it. This is achieved by increasing correlation between extracted marks and embedded ones. Our developed watermarking scheme will be tested on a 30- 256× 256 pixel-sized medical images against different attacks such as Noises, Filtering and JPEG Compression. For the main goal of preserving image quality and perceptual fidelity, we present the RPSNR as a distortion metric of perceptual image fidelity to estimate image degradation and in experimental results we demonstrate that it is the best distortion metric to measure image degradation that is correlated with the HVS.

The paper is organized as follows: Section 1.2 describes the new scheme of image watermarking and the main steps relevant to our new watermarking algorithm. We also draws a short panorama to explain the choice of the multi-resolution field with 5/3 wavelets decomposition. We expose turbo code used in our paper. Furthermore, we describe the utilities of using powerful Error Correcting Codes such as turbo code. Section 1.3, incorporates perceptual shaping, based on distortion metric for perceptual image quality, the RPSNR. This metric is able to reduce the perceptual distance between attacked watermarked images and unmarked ones. We list some simulation results showing that RPSNR is the best metric correlated with HVS to evaluate image degradation after dif-

ferent attacks. Section 1.4, reports a set of selected simulation results that clearly demonstrate that, even after rather severe addition of Noise, Filtering, and JPEG Compression, all 2000 bits are correctly detected in at least 90% of watermarked images while preserving image fidelity after watermarking scheme. Finally, section 1.5 comprises some concluding remarks.

### 1.2 New image watermarking algorithm

In this paper, we propose to embed the mark in the multi-resolution field by 5/3 wavelet decomposition. Our developed scheme is presented below:

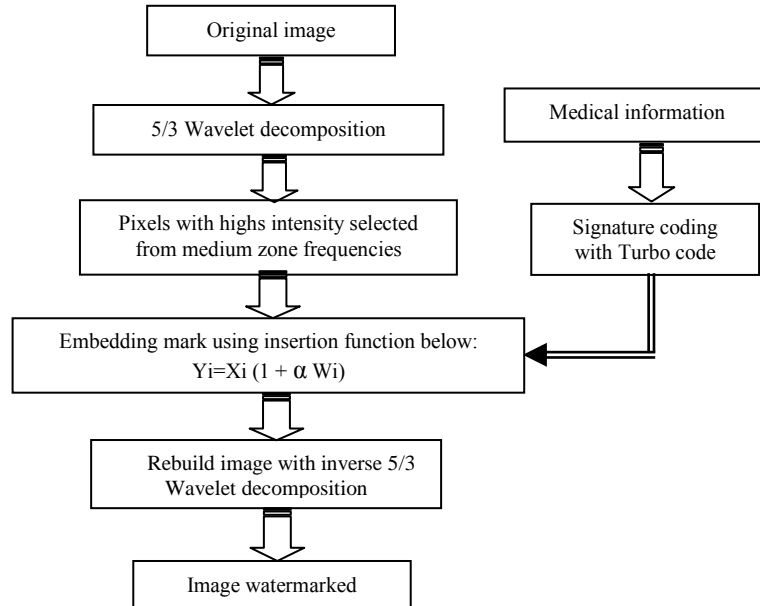

Fig. 1.1 The embedding algorithm

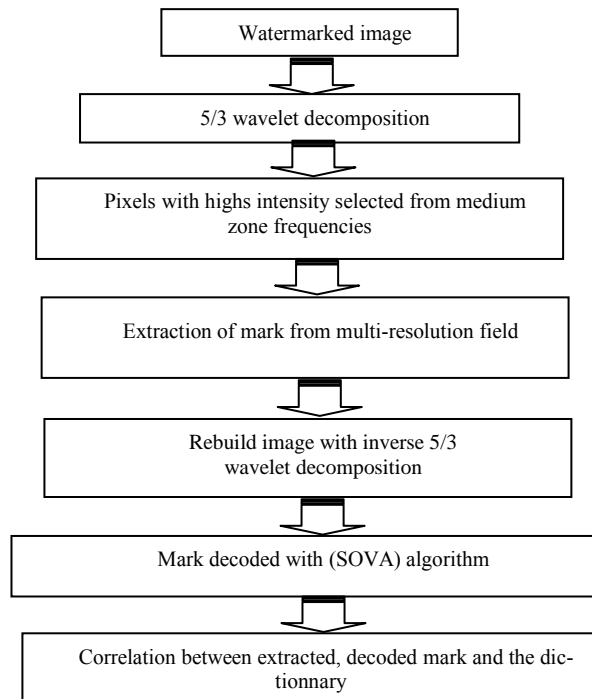

Fig. 1.2 The detection algorithm

### 1.2.1 The watermarking embedding algorithm

- Decomposition of medical image in 5/3 Wavelet.
- Choice of pixels embedded: if we embed a mark in high frequency zones, the mark may be altered or lost with high-pass Filtering attacks. Furthermore, if we embed marks in low frequency zones, the image can lose its perceptual quality because low-frequency contains the mark embedded in image. For this reason, we choose to embed a mark from pixels in medium-frequency zones. By this choice we attempt to attain an optimal trade-off between perceptual fidelity and signature integrity.
- The pixels embedded are also chosen from those that have the highest intensity from the mean frequency field. Pixels that have low intensity values can<sup>1</sup> be modified; and we here risk losing perceptual quality of images.
- We embed mark with the insertion function below:
  - $Y_i = X_i (1 + \alpha W_i)$ :
  - $Y_i$ : Watermarked image
  - $X_i$ : Original image
  - $W_i$ : Mark to be embedded composed of 2000 bits coded with 1/2 ratio turbo coder.
  - $\alpha$ : Visibility coefficient equal to 2 in our work.
- Image embedded is rebuilt after inverse decomposition in 5/3 Wavelet. Finally, we obtain the watermarked image.

### 1.2.2 The Public watermarking detection algorithm

- 5/3 Wavelet medical image decomposition.
- In the first step, pixels with the high-intensity are selected from the medium-zone frequencies.
- After that, we extract a mark from multi-resolution field with binary inverse transformation.
- Extracted mark is decoded by the use of the Soft Output Viterbe Algorithm (SOVA).
- We make a comparison between the extracted and decoded mark and a dictionary of 800 marks with the same nature to the embedded mark containing the reference mark (original mark). This comparison allows us to identify the similarity degree between extracted marks and the original mark. If the reference mark presents the high value of correlation, we can say that the detection of mark has succeeded. However, if the reference mark hasn't the maximum of correlation, detection mark is lost.

### 1.2.3 Use of multi-resolution field: The 5/3 Wavelet decomposition

Our choice of investigating the 5/3 Wavelet decomposition in our double watermarking algorithm is motivated by many reasons:

The 5/3 Wavelet decomposition is an integer to integer transform adapted for JPEG2000 Compression and comes in front for its frequent use in JPEG2000 norm. Consequently the image watermarked is robust against JPEG Compression attacks [16, 17].

For the reason of keeping image fidelity after watermarking process, we need perceptual metric correlated with Human Visual System. Nevertheless, in multi resolution field the image decomposition in sample bands is near to perception canal decomposition, so, we can easily choose a psycho-visual model to measure image degradation [2].

The 5/3 Wavelet equation decompositions are below:

$$d[n] = d_0[n] - \left\lfloor \frac{1}{2} (d[n] + d[n-1]) \right\rfloor \quad (1.1)$$

$$s[n] = s_0[n] + \left\lfloor \frac{1}{4} (d[n] + d[n-1]) + \frac{1}{2} \right\rfloor \quad (1.2)$$

To mark the selected coefficients, we use an embedding function. Therefore, the embedding function has an important role to specify the applied field of the watermarking. The following function is used to our watermark image:

$$y_i = x_i (1 + \alpha w_i).$$

$Y_i$ : Watermarked image

$X_i$ : Original image

$W_i$ : Mark to be embedded composed of 2000 bits coded with 1/2 ratio turbo coder.

$\alpha$ : Visibility coefficient.

### 1.2.4 Presentation of the turbo coder

The system transmission of turbo coder or parallel concatenation code consists in setting in parallel form of Recursive Systematic convolutional Coders (RSC)  $C_1$  and  $C_2$  [18]. The structural diagram of turbo codes is represented in the Figure 1.4.

$d_k$  is the input bit information.  $X_k$  is systematic output bit forming code words.

$Y_{1k}$  and  $Y_{2k}$  are the parities bits coming respectively from the first and the second recursive coder after interleaving the systematic bits or input bi

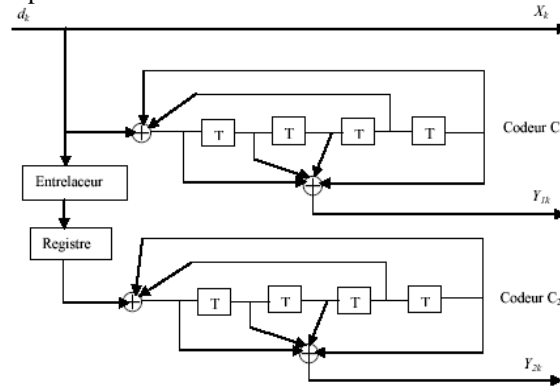

Fig. 1.4 Structural diagram of turbo coder

Turbo codes have been successfully used in digital communication systems in order to achieve reliable transmission on a noisy channel [19, 20, 21].

The idea of using turbo code in our “double watermarking” algorithm scheme comes from the efficiency of this ECC to increase robustness against Noises. Furthermore, the incorporation of turbo code in the formatting of the watermark increases the number of bits to hide in order to achieve higher payloads. Consequently, the number of repetitions of each bit of the watermark decreases in the same proportion [22]. Fortunately, turbo code using (SOVA) for decoding technique is an attractive solution for this application as it achieves powerful error-correction capability and higher payloads.

### 1.3 Perceptual Quality Metrics

Nowadays, the most popular distortion measures in the field of image are the Signal to Noise Ratio (SNR), and the Peak Signal to Noise Ratio (PSNR). They are usually measured in decibels ( $dB$ )

$SNR (dB) = 10 \log_{10} (SNR)$ .

Their popularity is very likely due to the simplicity of the metric. However, it is well known that these distortion metrics are not correlated with human vision [23]. This might be a problem for their application in digital watermarking since sophisticated watermarking methods exploit in one way or another the HVS.

In addition, using the above metric to quantify the distortion caused by a watermarking process might therefore result in misleading quantitative distortion measurements [24].

Furthermore, these metrics are usually applied to the luminance and chrominance channels of images [25], and they give a distortion value for all color channels.

In this paper, we introduce a metric of an image-quality evaluation entitled Relative Peak Signal to Noise Ratio (RPSNR). This distortion metric, that has no relation with the content characteristics of the image fits to the HVS and therefore is more suitable for digital watermarking.

In addition, this metric allows comparison even if the distortion is in a different color channel [26].

The estimation error for RPSNR as a function of packet loss rate and average loss burst length metric that represents path quality under different loss patterns.

The Relative Pick Signal to Noise Ratio (RPSNR) is used to evaluate the image quality by calculating the Relative Mean Square Error (RMSE) between the images to compare.

The equation as follows:

$$RMSE = \frac{1}{MN} \sum_{m=0}^{M-1} \sum_{n=0}^{N-1} \left[ 2 * \frac{|x(m,n) - y(m,n)|^2}{|x(m,n) + y(m,n)|} \right] \quad (1.3)$$

$$RPSNR = 10 \cdot \text{Log}_{10} \left\{ \frac{(\text{valeur max du signal})_2}{RMSE} \right\} \quad (1.4)$$

M and N are the numbers of pixels lengthwise and width wise per image.  
X and y are the grey scale of the images to compare.

In order to properly demonstrate the performance of RPSNR in watermarking schemes and allow a fair comparison between different perceptual quality metrics, the setup test conditions are of crucial importance. Table 1.1 lists different mean values of PSNR, WPSNR and RPSNR after the most famous types of distortion and attacks on a database of 30, 256×256 pixel-sized medical images. Figure 1.5 presents some images from the above-mentioned database.

**Table 1.1** Different means values of PSNR, WPSNR and RPSNR after different attacks in image banks

Distortion type	PSNR	WPSNR	RPSNR
Mean shift	24.6090	35.6873	64.3123
Contrast stretching	24.6003	35.7453	57.913
Impulsive Salt and paper noise	24.6499	35.4654	63.6996
Multiplicative Speckle noise	24.6186	34.6206	66.9165
Additive Gaussian noise	24.5906	35.5855	62.4892
floue	24.6054	45.0642	63.4734
JPEG Compression	24.7849	38.7652	62.6179

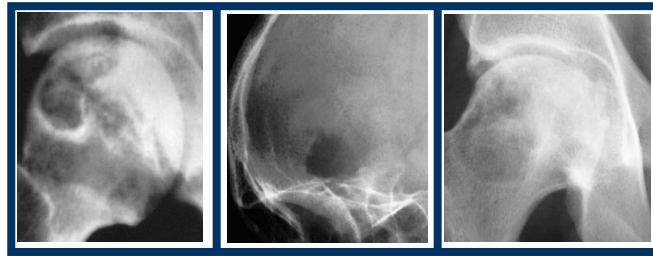

**Fig. 1.5** Some figures from the database of 30 medicals images

## 1.4 Preliminary results

### 1.4.1 Robustness against attacks

This section displays first the experimental results carried out on a database of 800 marks in witch the extracted and decoded marks are tested. The test technique is made by correlation between the extracted and decoded marks and the dictionary.

Figures 1.6, 1.7 and 1.8, demonstrate that the marks are correctly detected from our simulation results from watermarked images after Noises attacks, JPEG Compression and Filtering attacks.

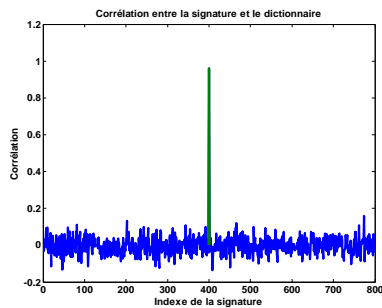

**Fig. 1.6.** Succeeded detection of a mark after correlation between extracted and decoded mark and the dictionary after Gaussian noise (0.03) attack. Correlation=0.90

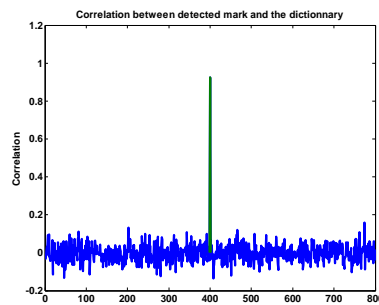

**Fig. 1.7.** Succeeded detection of a mark after correlation between extracted and decoded mark and the dictionary after image Compression of Quality 60. Correlation 0.83

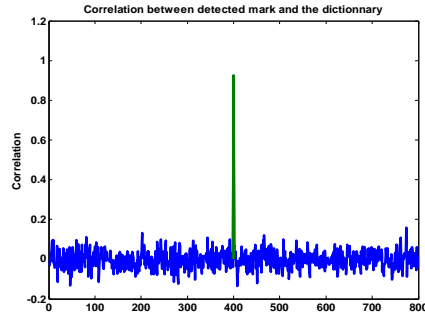

**Fig. 1.8.** Succeeded detection of a mark after correlation between extracted and decoded mark and the dictionary after Gaussian Filter. Correlation=0. 92

**1.4.2 Fidelity of watermarked images after attacks**

We present in the following legend a summary of attacks against which the watermarked images are tested and evaluated in order to validate in our proposed approach, the perceptual fidelity after embedding of 2000 bits.

**1.4.2.1 Fidelity against Noises attacks**

It is quite relevant to evaluate the robustness of the suggested method against Noise. In fact, in the medical field, the used instruments add different types of Noise types to the medical images. We have tested our new approach using 10 different Noises generations and by modifying variances at each time. From the figure 1.9, we can observe values of RPSNR that are always higher than 30 dB. This makes it obvious that the image quality is good and these new watermarked images algorithm is powerful to keep image fidelity even after Noise attack.

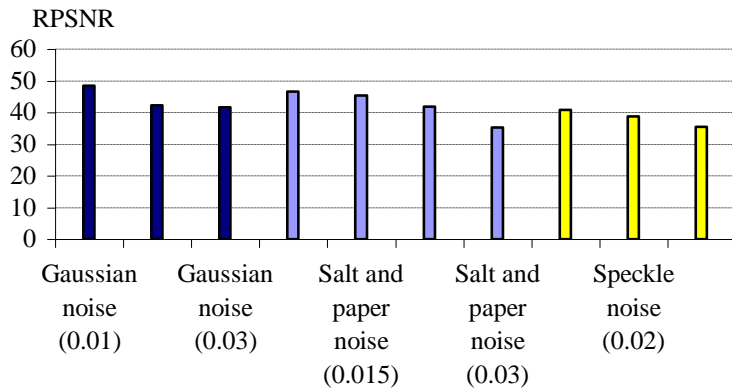

**Fig. 1.9** Mean values of RPSNR for 30 test images watermarked and attacked by different Types of Noises

**1.4.2.2 Fidelity against JPEG Compression attacks**

We often need to apply JPEG Compression to the medical images for archive or transmission purposes. We tried to test the robustness of our scheme with different compression ratio from 90%, 70%, 50%, 30% and 10%. From figures 1.10, we can remark that fidelity is improved after different qualities of JPEG Compression attacks.

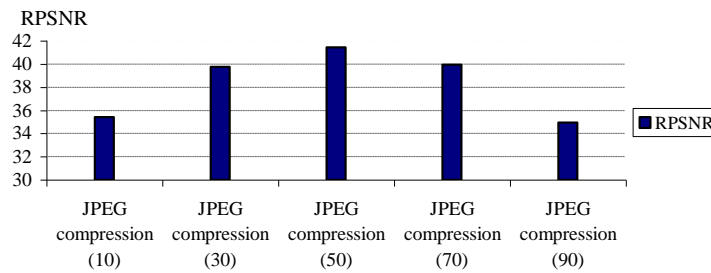

**Fig. 1.10.** Mean values of RPSNR for 30 test images watermarked and attacked by different ratio of JPEG Compression

### 1.4.2.3 Fidelity against Filtering attacks

We have tested the robustness of our proposed method face to 4 filter types' attacks: Gaussian, Unsharp, Average and Motion. Figure 1.11 displays good values of RPSNR. It follows then that fidelity in images is improved after Filtering attacks.

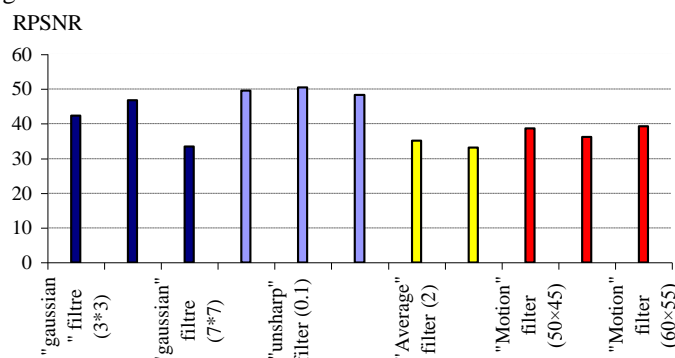

Fig. 1.11. Mean values of RPSNR for 30 tests images Watermarked and attacked by different filters

## 1.5 Conclusions

In this paper, we have proposed to enhance a still image with a watermarking scheme based on the insertion of mark in the multi-resolution field by 5/3 wavelet decomposition. The main goal of this approach is to benefit from the advantages of the multi-resolution field in the watermarking process and the turbo code one. The watermarking scheme uses powerful error-correcting turbo codes to improve resistance against attacks. Simulation results show that for a given payloads 2000-sized bits and after the severe addition of Noises, JPEG Compression and Filtering, all bits are detected in at least 90% from the multi-resolution field. Furthermore, for different tested attacks the perceptual metric incorporated the RPSNR allow us to keep parfait values of images distortions above 30 dB. Consequently, we have a good perceptual fidelity in images after watermarking process.

## References

- [1.] Cox IJ, Miller ML, Bloom JA (2001) Digital Watermarking. New York: Morgan Kaufmann
- [2.] Rey C, Dugelay J-L (2000) Tech. demo. Image Watermarking for Owner and Content Authentication. ACM Multimedia, Los Angeles
- [3.] Chemak Chokri, Bouhleb Mohamed Salim, Lapayre Jean Christophe (2006) Algorithme de Tatouage Robuste et Aveugle pour la Déontologie et le Transfert des Informations Médicales: Le Tatouage Combinée ATRADTIM. Brevet déposés à l'INNORPI, SN06448
- [4.] Kong Xuan, Feng Rui (2001) Watermarking medical signals for telemedicine. IEEE Transactions on Information Technology in Biomedicine 5(3):195-201
- [5.] Tricili H, Bouhleb MS, Derbel N, Kamoun L (2002) A new medical image watermarking scheme for a better teliagnosis. IEEE conference on Systems, Man and Cybernetics: SMC, Hammamet, Tunisia
- [6.] Miller ML, Doerr GJ, Cox IJ (2004) Applying informed coding and informed embedding to design a robust high capacity watermark. IEEE Transactions on image processing 6(13):792-807
- [7.] Miller ML, Doerr GJ, Cox IJ (2002) Dirty-paper trellis codes for watermarking. In: Proc. Int. Conf. on Image Processing, Rochester, USA, 2:129-132
- [8.] Hernández JR, Delaigle J-F, Macq B (2000) Improving Data hiding by using convolutional codes and soft-decision decoding. In: Proceedings of SPIE - Security and Watermarking of Multimedia Contents II, San Jose, USA pp 24-48
- [9.] Darbon J, Sankur B, Maître H (2000) Error correcting code performance for watermark protection. In: Proceedings of SPIE - Security and Watermarking of Multimedia Contents III, San Jose, USA
- [10.] Baudry S, Delaigle J-F, Sankur B, Macq B, Maître H (2001) Analyses of error correction strategies for typical communication channels in watermarking. Signal Processing 81(6):1239-1250
- [11.] Tefas A, Pitas I (2000) Multi-bit image watermarking robust to geometric distortions. IEEE International conference on Image Processing, Vancouver, Canada, September 2000
- [12.] Inoue H, Miyazaki A, Yamamoto A, Katsura T (1999) A digital watermark based on the Wavelet transform and its robustness on image compression and transformation. IEICE Trans. Fund. Electron, Common. Comput. Sci., E82-A: 2-10
- [13.] Pereira S, Voloshynovskiy S, Pun T (2000) Effective Channel Coding for DCT Watermarks. IEEE International conference on Image Processing, Vancouver, Canada

- [14.] Brandão T, Queluz MP, Rodrigues A (2001) Improving Spread Spectrum Based Image Watermarking Through Non-binary Channel Coding. In: Proceedings of 3<sup>rd</sup> Conference on Telecommunications, Figueirada
- [15.] Kesal M, Mýhçak MK, Koetter R, Moulin P (2000) Iteratively Decodable Codes for Watermarking Applications. Proceedings of 2nd International Symposium on Turbo Codes and Related Topics, Brest, France
- [16.] Chemak Chokri, Bouhleb Mohamed Salim, Lapayre Jean Christophe (2007) Un schéma de tatouage basé sur les ondlettes 5 /3 et le turbo code pour la robustesse du tatouage contre les bruits gaussien et la compression JPEG 5èmes Journées Scientifiques de l'Ecole de l'aviation de Borj el Amri, Tunisie.
- [17.] Adams, Kossentini (2000) Reversible Integer-to-Integer Wavelet transforms for image compression against attack of JPEG compression, evaluation and analysis. IEEE Transactions on image processing 9(6)
- [18.] Berrou C, Glavieux A (1996) Near optimum error correcting coding and decoding: Turbo codes. IEEE Trans. Comm., pp 1261–1271
- [19.] Chemak C, Bouhleb Mohamed Salim (2006) Near Shannon limit for turbo code with short frames. In: 2nd IEEE International Conference on Information and Communication Technologies from Theory to Applications (ICTTA'06), Damascus Syria, ISBN: 0-7803-9521-2
- [20.] Chan F (1999) Adaptive Viterbi decoding of turbo codes with short frames. In: Proc. IEEE Commun. interleaver Good component codes have also been Theory Mini-Conference, in conjunction with ICC'99, pp 47-51
- [21.] Chappelier V, Guillemot C, Marinkovic S (2003) Turbo trellis coded quantization. In: Proc. Int. Symposium on Turbo Codes, Brest, France
- [22.] Rey C, Amis K, Dugelay J-L, Pyndiah R, Picart A (2003) Enhanced robustness in image watermarking using block turbo codes. In: Proc. SPIE-Security and Watermarking of Multimedia Contents V, 5020:330–336